

FEATURES

LO Frequency:	550 – 1100 MHz
Image Rejection:	37 dB
LO-RF Isolation:	65 dB
Input IP3:	+15 dBm
Input P1dB:	+7 dBm
LO Power:	+14 dBm

DESCRIPTION

The IRM0511B is an image-reject mixer with enhanced linearity. The desired RF sideband is downconverted to the IF while the unwanted RF sideband is internally rejected.

The IRM0511B maintains excellent image rejection across multi-octave IF frequency bandwidths. In-stock IF bands include:

- 10 MHz to 50 MHz
- 30 MHz to 90 MHz

Other common IF bands are available. Please specify IF=RF-LO or IF=LO-RF and IF band when ordering.

ELECTRICAL SPECIFICATIONS

Test Conditions: +25°C, LO Input = +14 dBm, RF input = 0 dBm @ LO+30 MHz unless otherwise noted.

PARAMETER	TEST CONDITIONS	MIN	TYP	MAX	UNITS
LO Frequency Range ¹		550		1100	MHz
LO Power		+13	+14	+16	dBm
LO VSWR			1.4:1		Ratio
RF VSWR			2.0:1		Ratio
IF Output Impedance ²			50		Ω
Conversion Loss ²			8.5	10.5	dB
Noise Figure ²			9		dB
Input IP2 ²			+64		dBm
Input IP3 ²	2-Tone, Δf = 1 MHz		+15		dBm
Input P1dB ²			+7		dBm
LO-RF Isolation	No IF input	55	65		dB
LO-IF Isolation	No IF input		45		dB
Image Rejection ²		27	37		dB
Operating Temperature Range		-40		+85	°C
RF/IF Input Power w/o Damage				+25	dBm

Notes:

1. Standard unit is configured for IF=RF-LO operation and 10 MHz to 50 MHz IF band option.
2. Specified over entire IF frequency band.

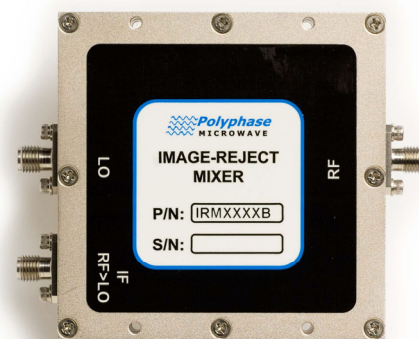

BLOCK DIAGRAM
(IF=RF-LO CONFIGURATION)

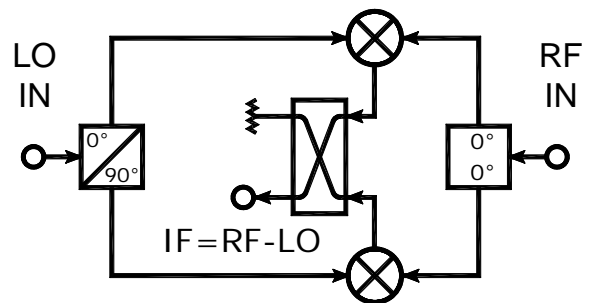

TYPICAL PERFORMANCE CHARACTERISTICS

Standard Test Conditions: +25°C, LO Input = +14 dBm, RF input = 0 dBm @ LO+30 MHz

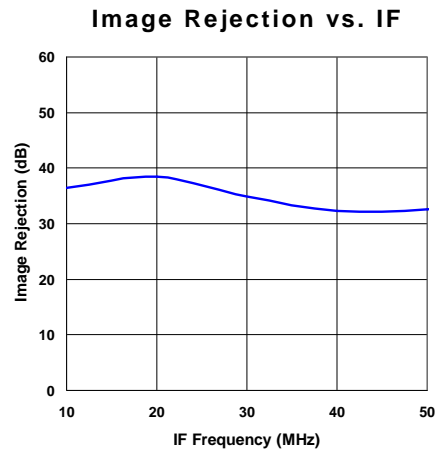
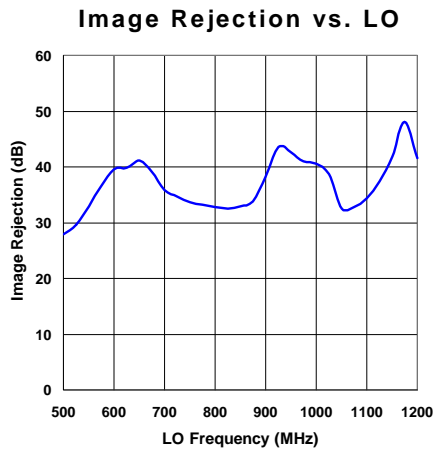
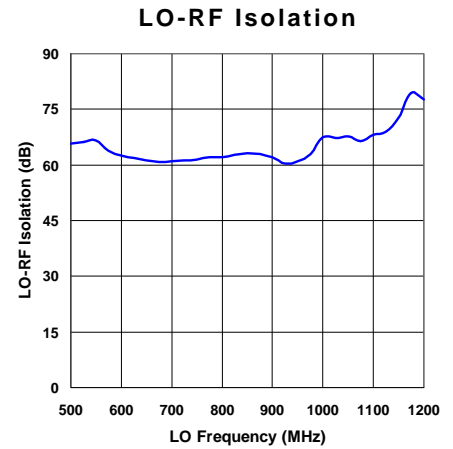
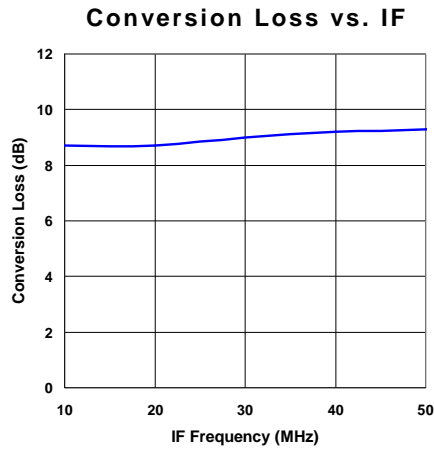
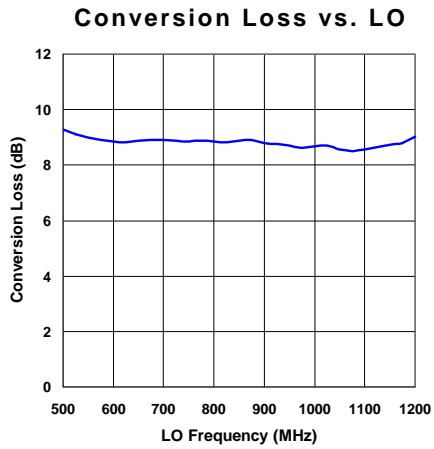

CASE DRAWING

