

**FEATURES**

LO Frequency:	5000 – 10000 MHz
Image Rejection:	35 dB
LO-RF Isolation:	45 dB
Input IP3:	+23 dBm
Input P1dB:	+11 dBm
LO Power:	+17 dBm

**DESCRIPTION**

The IRM50100B is an image-reject mixer with enhanced linearity. The desired RF sideband is downconverted to the IF while the unwanted RF sideband is internally rejected.

The IRM50100B maintains excellent image rejection across multi-octave IF frequency bandwidths. In-stock IF bands include:

- 10 MHz to 50 MHz
- 30 MHz to 90 MHz

Other common IF bands are available. Please specify IF=RF-LO or IF=LO-RF and IF band when ordering.

**ELECTRICAL SPECIFICATIONS**

Test Conditions: +25°C, LO Input = +17 dBm, RF input = 0 dBm @ LO+30 MHz unless otherwise noted.

PARAMETER	TEST CONDITIONS	MIN	TYP	MAX	UNITS
LO Frequency Range <sup>1</sup>		5000		10000	MHz
LO Power		+16	+17	+19	dBm
LO VSWR			1.5:1		Ratio
RF VSWR			2.0:1		Ratio
IF Output Impedance <sup>2</sup>			50		Ω
Conversion Loss <sup>2</sup>			7.5	11.5	dB
Noise Figure <sup>2</sup>			8		dB
Input IP2 <sup>2</sup>			+67		dBm
Input IP3 <sup>2</sup>	2-Tone, Δf = 1 MHz		+23		dBm
Input P1dB <sup>2</sup>			+11		dBm
LO-RF Isolation	No IF input	25	45		dB
LO-IF Isolation	No IF input		35		dB
Image Rejection <sup>2</sup>		25	35		dB
Operating Temperature Range		-40		+85	°C
RF/IF Input Power w/o Damage				+25	dBm

Notes:

1. Standard unit is configured for IF=RF-LO operation and 10 MHz to 50 MHz IF band option.
2. Specified over entire IF frequency band.

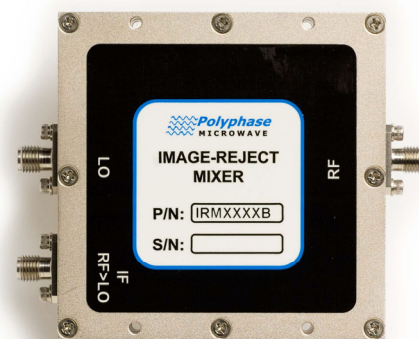

**BLOCK DIAGRAM**  
**(IF=RF-LO CONFIGURATION)**

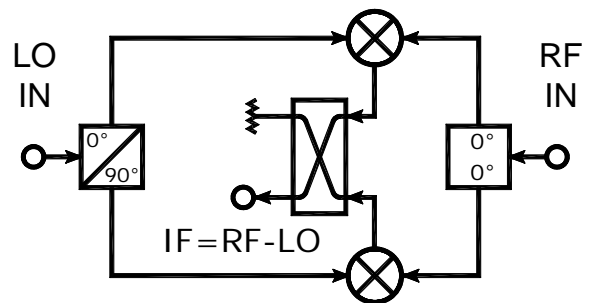

**TYPICAL PERFORMANCE CHARACTERISTICS**

Standard Test Conditions: +25°C, LO Input = +17 dBm, RF input = 0 dBm @ LO+30 MHz

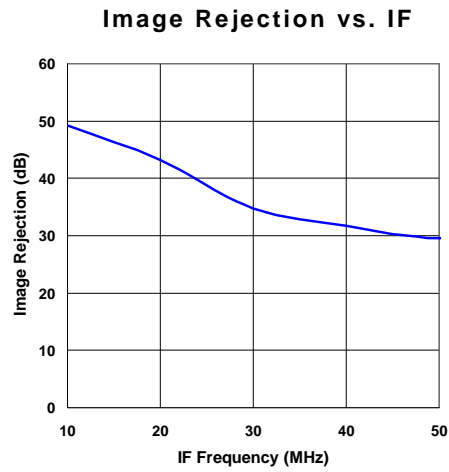
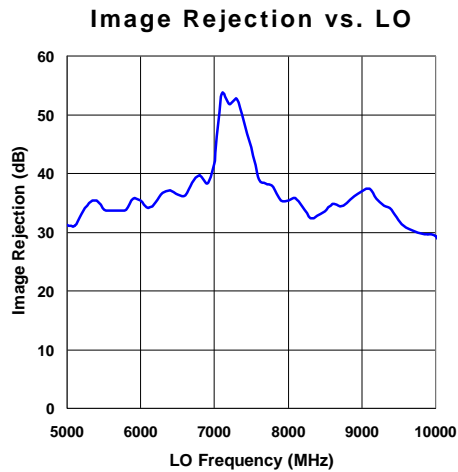
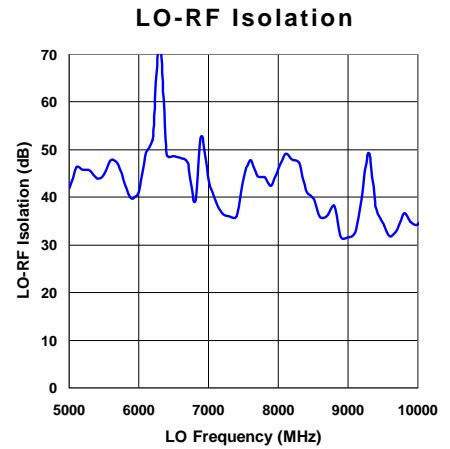
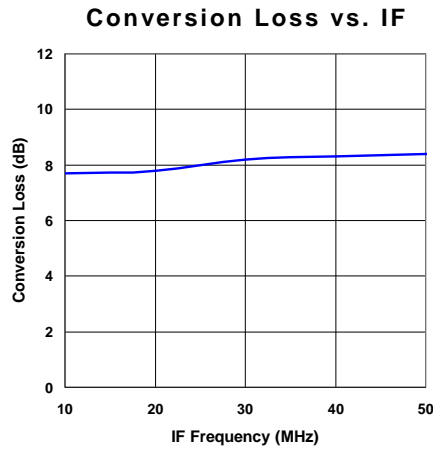
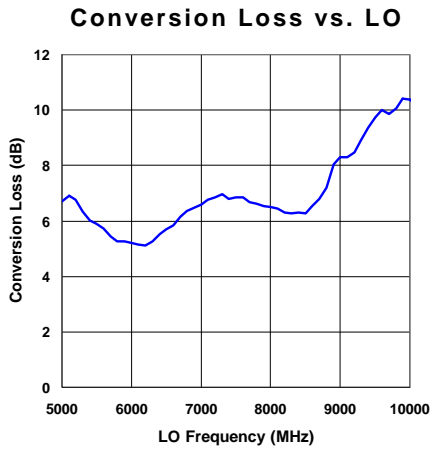

**CASE DRAWING**

