

FEATURES

LO/RF Frequency:	1400 – 2200 MHz
Input IP2:	+65 dBm
Input IP3:	+18 dBm
Input P1dB:	+7 dBm
Amplitude imbalance:	0.1 dB rms
Quadrature phase error:	1.5° rms
LO Power:	+14 dBm

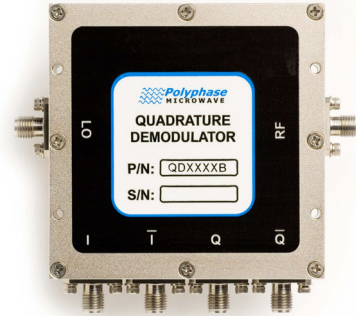

DESCRIPTION

The QD1422B is a quadrature (I/Q) demodulator optimized for direct conversion receivers. When the passive demodulator is supplied with a LO drive signal, the RF input is directly converted to differential I and Q baseband outputs.

Internally matched lowpass filters provide anti-alias functionality for interfacing to high-speed A/D converters.

For more information on interfacing the QD1422B to differential A/D converters and single-ended loads, please see Application Note 102A, "Interface Circuits for the QD Series Quadrature Demodulators."

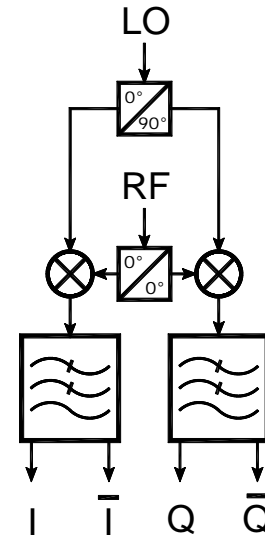

TYPICAL APPLICATION: DIRECT CONVERSION RECEIVER

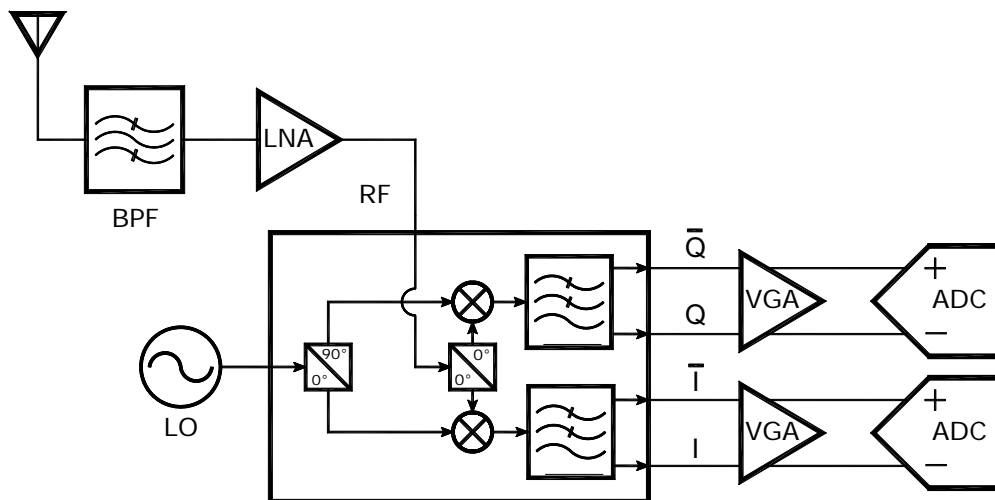

ELECTRICAL SPECIFICATIONS

Test Conditions: +25°C, LO = +14 dBm, RF = 0 dBm @ LO+100 kHz unless otherwise noted.

PARAMETER	TEST CONDITIONS	MIN	TYP	MAX	UNITS
Frequency Range ¹		1400		2200	MHz
LO Power		+13	+14	+16	dBm
LO VSWR			1.5:1		Ratio
RF VSWR			2.0:1		Ratio
I/Q Baseband Filter Bandwidth ²	<1 dB Flatness	DC		275	MHz
I/Q Baseband Filter Stop Band ²	>25 dB Rejection	450		5000	MHz
I/Q Differential Output Impedance			100		Ω
I/Q Baseband DC Offset	Into 100 Ω load	-5		+5	mV
Conversion Loss			6.5	8.5	dB
Noise Figure	No RF input drive		7		dB
Input IP2			+65		dBm
Input IP3	2-Tone, Δf = 1 MHz		+18		dBm
Input P1dB			+7		dBm
LO-RF Isolation	No RF input drive		65		dB
LO-IF Isolation	No RF input drive		70		dB
Amplitude Imbalance		-0.3	±0.1	+0.3	dB
Quadrature Phase Error		-3.5	±1.5	+3.5	Degree
Operating Temperature Range		-40		+85	°C
LO/RF Input Power w/o Damage				+25	dBm

Notes:

1. When RF > LO frequency: $I = \cos(t)$, $\bar{I} = -\cos(t)$, $Q = \sin(t)$, $\bar{Q} = -\sin(t)$
2. Standard lowpass filters. Contact factory for other options.

CASE DRAWING

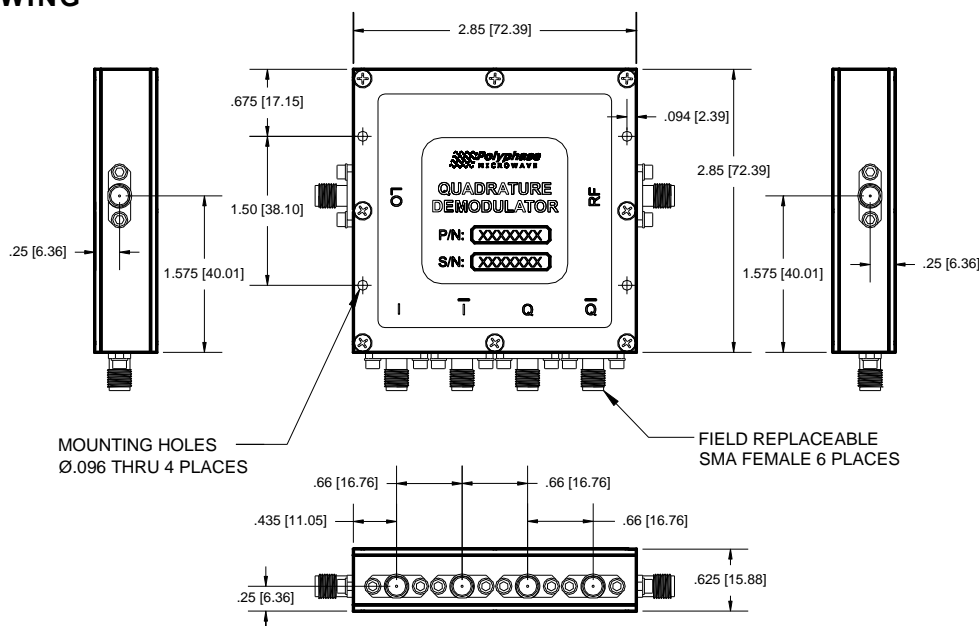

TYPICAL PERFORMANCE CHARACTERISTICS

Standard Test Conditions: +25°C, LO = +14 dBm, RF input = 0 dBm @ LO+100 kHz.

Conversion Loss

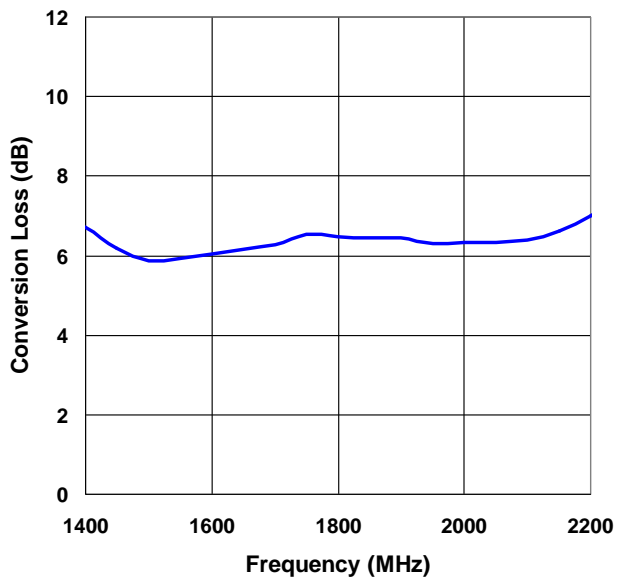

LO-RF Isolation

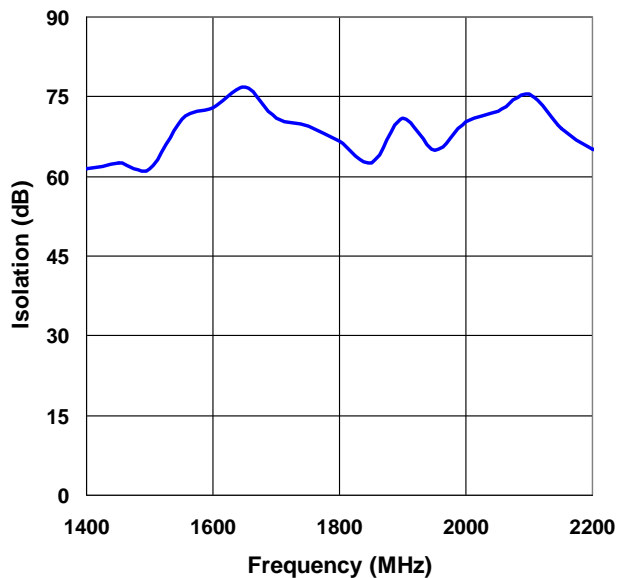

Amplitude Imbalance

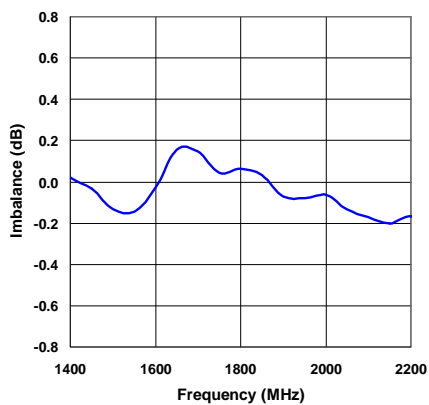

Quadrature Phase Error

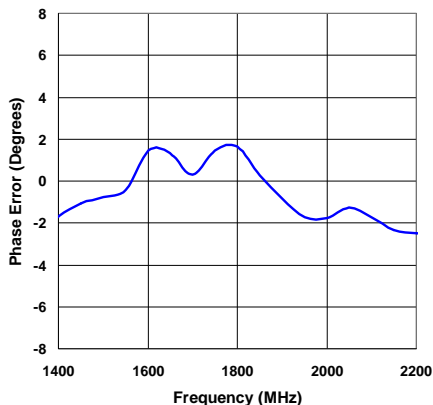

DC Offsets

