

FEATURES

LO/RF Frequency:	550 – 1100 MHz
Input IP3:	+14 dBm
Noise Floor:	-173 dBm/Hz
Sideband Suppression:	-35 dBc
LO Leakage:	-52 dBm
LO Power:	+14 dBm

DESCRIPTION

The QM0511A is a quadrature (I/Q) modulator optimized for direct modulation of an RF carrier. Differential I and Q inputs are mixed with the local oscillator (LO) to produce a modulated RF output.

Internally matched lowpass filters provide anti-alias functionality for removing Nyquist images and wideband noise when interfacing to high-speed D/A converters.

For more information on interfacing the QM0511A to high-speed D/A converters and single-ended sources, please see Application Note 101A, "Driving the QM Series Quadrature Modulators."

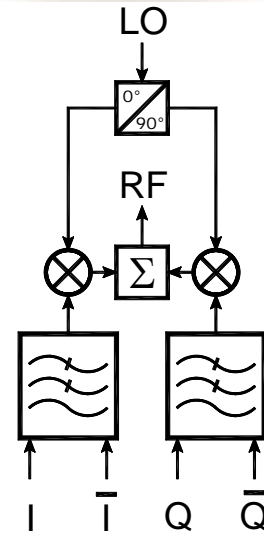
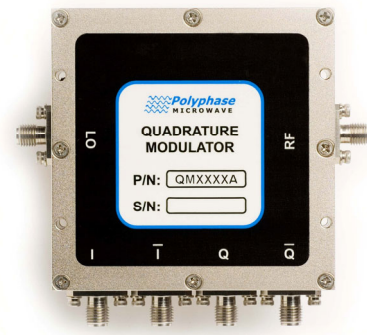
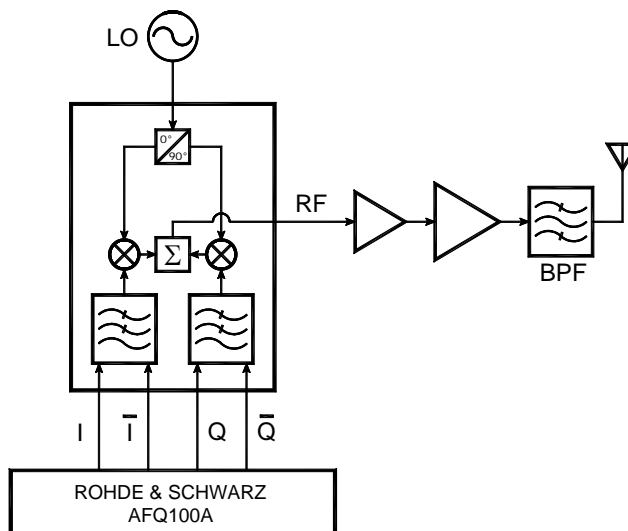
TYPICAL APPLICATION: DIRECT CONVERSION TRANSMITTER

ELECTRICAL SPECIFICATIONS

Test Conditions: +25°C, LO = +14 dBm, I/Q inputs = 0 dBm total @ 100 kHz unless otherwise noted.

PARAMETER	TEST CONDITIONS	MIN	TYP	MAX	UNITS
Frequency Range		550		1100	MHz
LO Power		+13	+14	+16	dBm
LO VSWR			1.4:1		Ratio
RF VSWR			2.0:1		Ratio
I/Q Baseband Filter Bandwidth ¹	<1 dB Flatness	DC		275	MHz
I/Q Baseband Filter Stop Band ¹	>25 dB Rejection	450		5000	MHz
I/Q Differential Input Impedance			100		Ω
Conversion Loss			8.5	10.5	dB
Input IP3	2-Tone, Δf = 1 MHz		+14		dBm
Input P1dB			+7		dBm
LO Leakage at RF Port	No RF input drive		-52	-40	dBm
LO-IF Isolation	No RF input drive		70		dB
Sideband Suppression ²			-35	-28	dBc
Amplitude Imbalance		-0.5	±0.15	+0.5	dB
Quadrature Phase Error		-4	±1	+4	Degree
Output Noise Floor			-173		dBm/Hz
Operating Temperature Range		-40		+85	°C
LO/RF Input Power w/o Damage				+25	dBm

Notes:

1. Standard lowpass filters. Contact factory for other options.
2. For upper sideband operation: $I = \cos(t)$, $\bar{I} = -\cos(t)$, $Q = \sin(t)$, $\bar{Q} = -\sin(t)$

CASE DRAWING

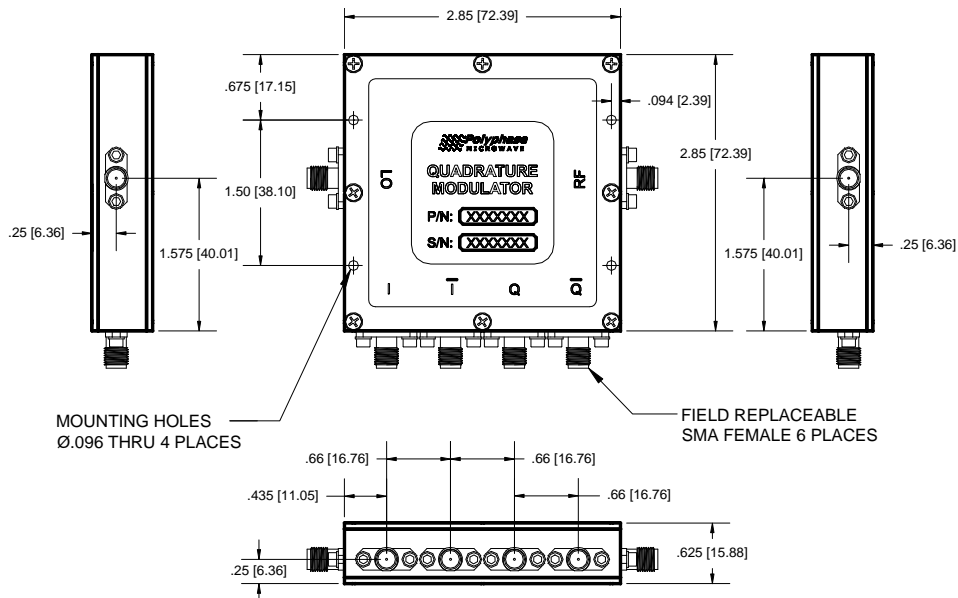

TYPICAL PERFORMANCE CHARACTERISTICS

Standard Test Conditions: +25°C, LO = +14 dBm, I/Q inputs = 0 dBm total @ 100 kHz.

Conversion Loss

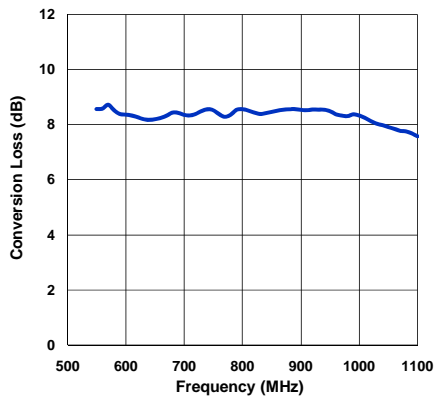

Input IP3

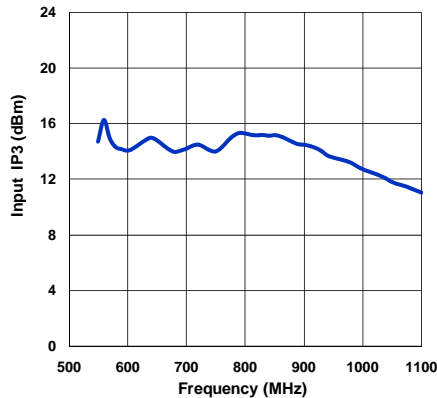

LO Leakage at RF Port

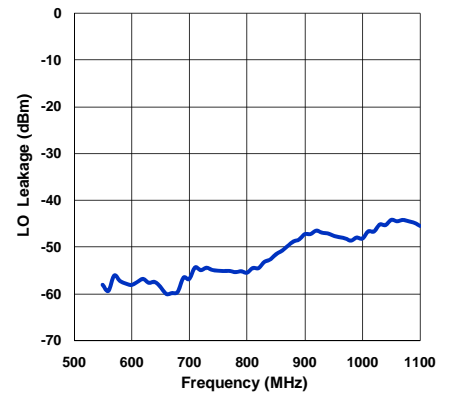

Amplitude Imbalance

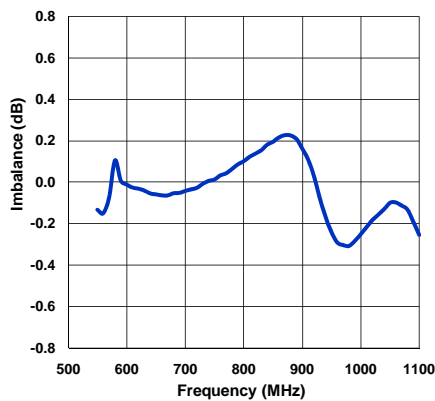

Quadrature Phase Error

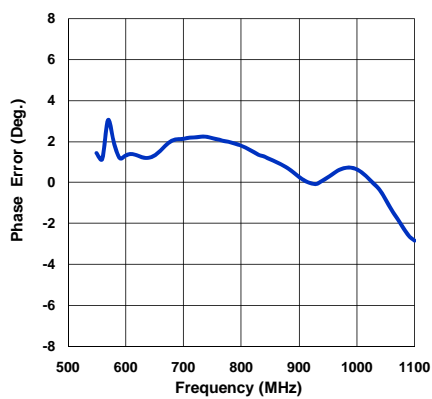

Sideband Suppression

