

**FEATURES**

LO/RF Frequency:	1200 – 1400 MHz
Input IP3:	+18 dBm
Noise Floor:	-173 dBm/Hz
Sideband Suppression:	-42 dBc
LO Leakage:	-50 dBm
LO Power:	+14 dBm

**DESCRIPTION**

The QM1214A is a quadrature (I/Q) modulator optimized for direct modulation of an RF carrier. Differential I and Q inputs are mixed with the local oscillator (LO) to produce a modulated RF output.

Internally matched lowpass filters provide anti-alias functionality for removing Nyquist images and wideband noise when interfacing to high-speed D/A converters.

For more information on interfacing the QM1214A to high-speed D/A converters and single-ended sources, please see Application Note 101A, "Driving the QM Series Quadrature Modulators."

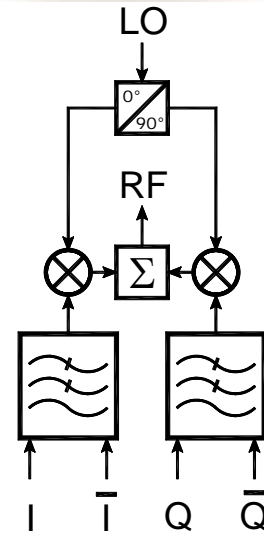
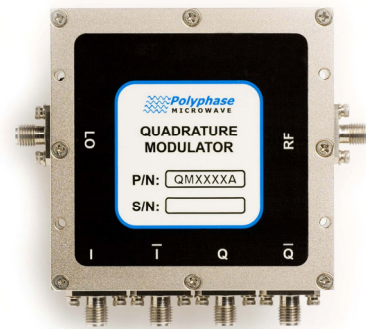

**TYPICAL APPLICATION: DIRECT CONVERSION TRANSMITTER**

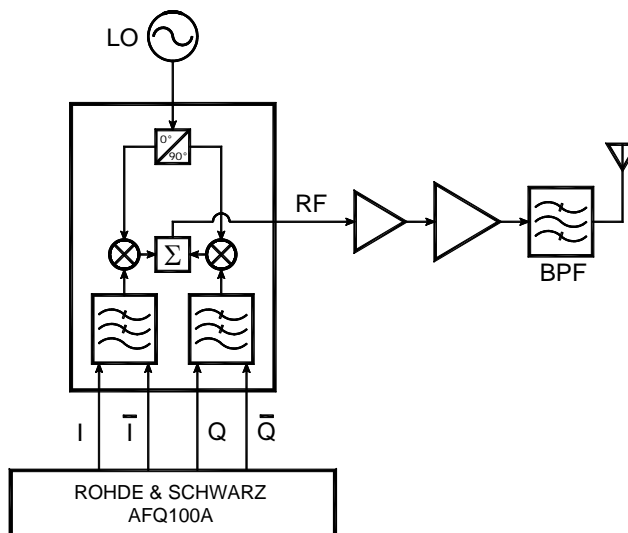

**ELECTRICAL SPECIFICATIONS**

Test Conditions: +25°C, LO = +14 dBm, I/Q inputs = 0 dBm total @ 100 kHz unless otherwise noted.

PARAMETER	TEST CONDITIONS	MIN	TYP	MAX	UNITS
Frequency Range		1200		1400	MHz
LO Power		+13	+14	+16	dBm
LO VSWR			1.6:1		Ratio
RF VSWR			3.0:1		Ratio
I/Q Baseband Filter Bandwidth <sup>1</sup>	<1 dB Flatness	DC		275	MHz
I/Q Baseband Filter Stop Band <sup>1</sup>	>25 dB Rejection	450		5000	MHz
I/Q Differential Input Impedance			100		Ω
Conversion Loss			7	9	dB
Input IP3	2-Tone, Δf = 1 MHz		+18		dBm
Input P1dB			+8		dBm
LO Leakage at RF Port	No RF input drive		-50	-40	dBm
LO-IF Isolation	No RF input drive		70		dB
Sideband Suppression <sup>2</sup>			-42	-32	dBc
Amplitude Imbalance		-0.2	±0.05	+0.2	dB
Quadrature Phase Error		-2	±1	+2	Degree
Output Noise Floor			-173		dBm/Hz
Operating Temperature Range		-40		+85	°C
LO/RF Input Power w/o Damage				+25	dBm

Notes:

1. Standard lowpass filters. Contact factory for other options.
2. For upper sideband operation:  $I = \cos(t)$ ,  $\bar{I} = -\cos(t)$ ,  $Q = \sin(t)$ ,  $\bar{Q} = -\sin(t)$

**CASE DRAWING**

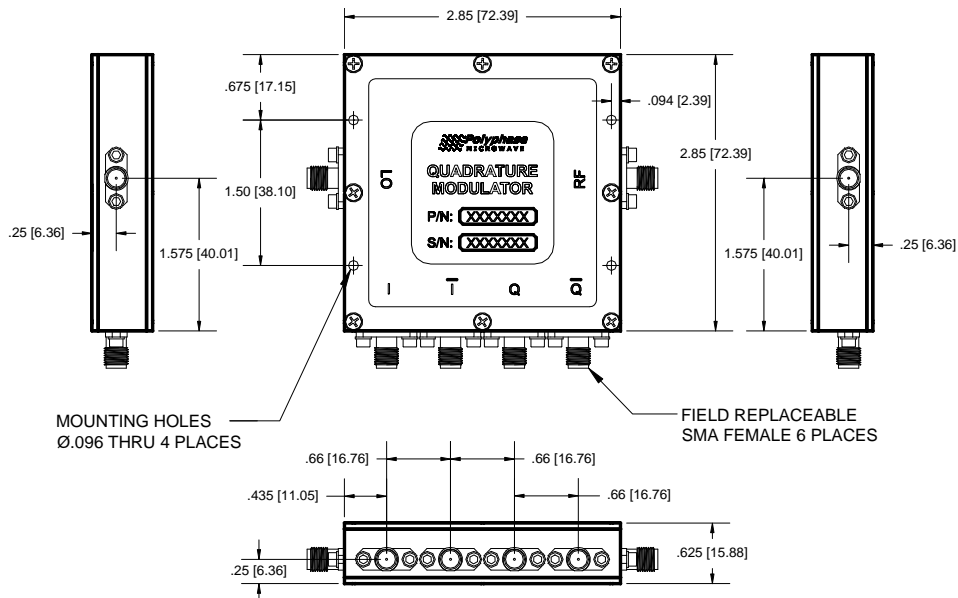

**TYPICAL PERFORMANCE CHARACTERISTICS**

Standard Test Conditions: +25°C, LO = +14 dBm, I/Q inputs = 0 dBm total @ 100 kHz.

**Conversion Loss**

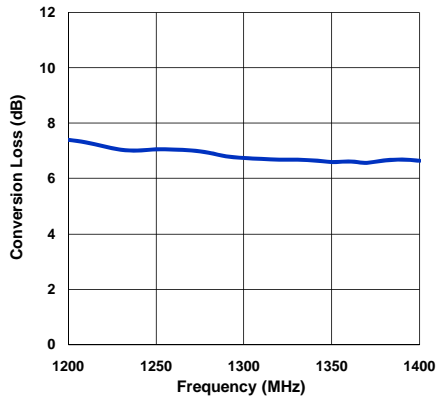

**Input IP3**

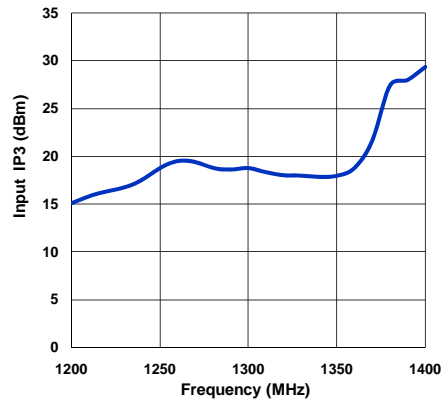

**LO Leakage at RF Port**

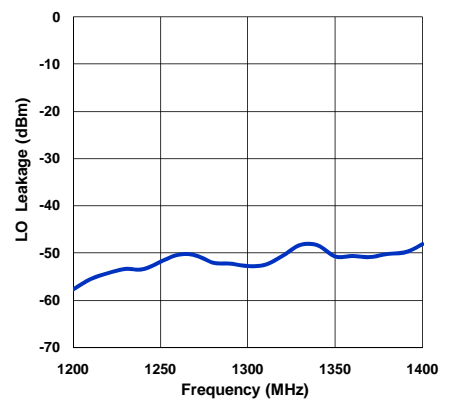

**Amplitude Imbalance**

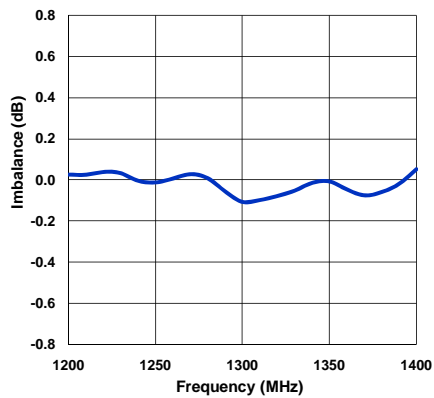

**Quadrature Phase Error**

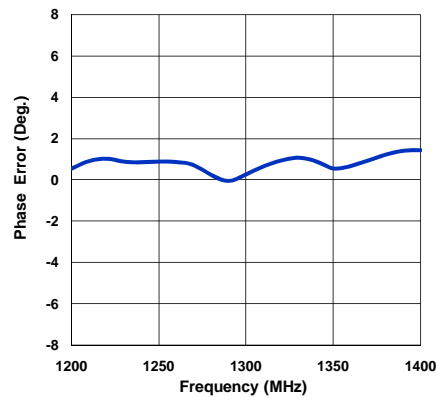

**Sideband Suppression**

