

**FEATURES**

LO/Rf Frequency:	3400 – 6800 MHz
Input IP3:	+25 dBm
Input P1dB:	+12 dBm
Noise Floor:	-173 dBm/Hz
Sideband Suppression:	-31 dBc
LO Leakage:	-30 dBm
LO Power:	+19 dBm

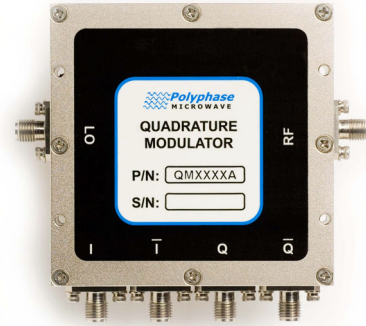

**DESCRIPTION**

The QM3468A is a quadrature (I/Q) modulator optimized for direct modulation of an RF carrier. Differential I and Q inputs are mixed with the local oscillator (LO) to produce a modulated RF output.

Internally matched lowpass filters provide anti-alias functionality for removing Nyquist images and wideband noise when interfacing to high-speed D/A converters.

For more information on interfacing the QM3468A to high-speed D/A converters and single-ended sources, please see Application Note 101A, "Driving the QM Series Quadrature Modulators."

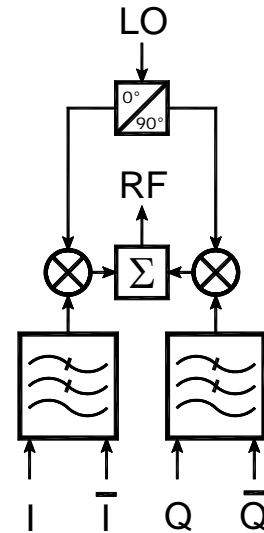

**TYPICAL APPLICATION: DIRECT CONVERSION TRANSMITTER**

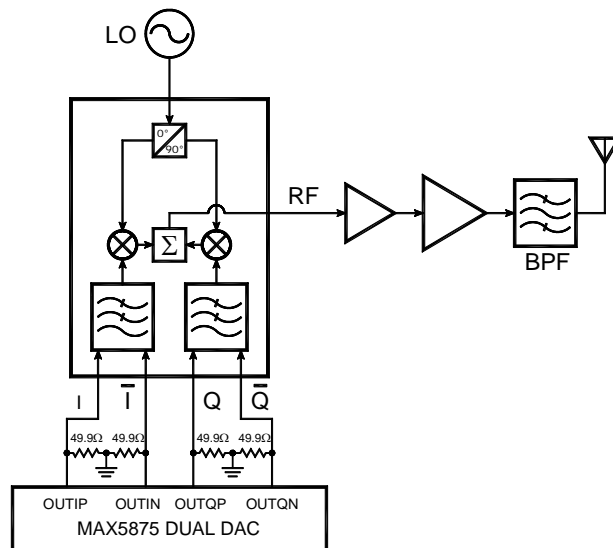



**TYPICAL PERFORMANCE CHARACTERISTICS**

Standard Test Conditions: +25°C, LO = +19 dBm, I/Q inputs = 0 dBm total @ 100 kHz.

**Conversion Loss**

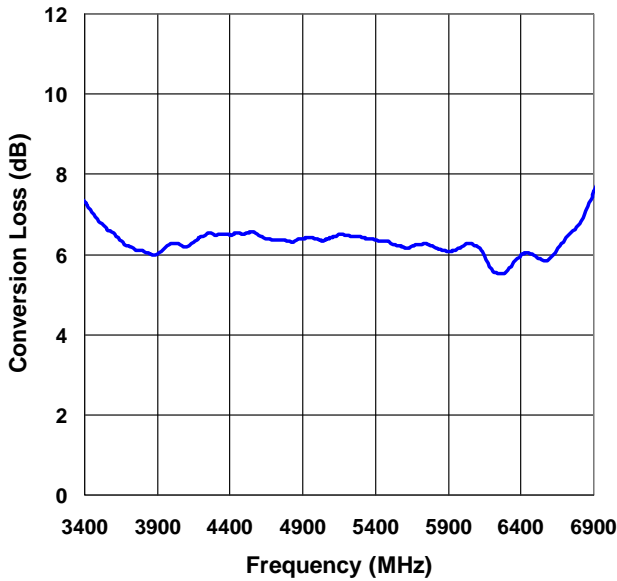

**LO Leakage at RF Port**

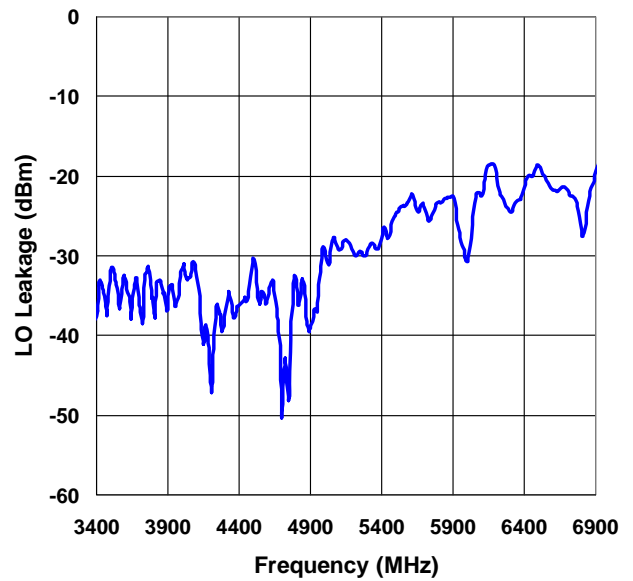

**Amplitude Imbalance**

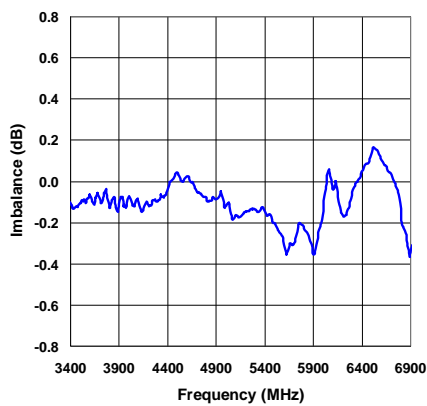

**Quadrature Phase Error**

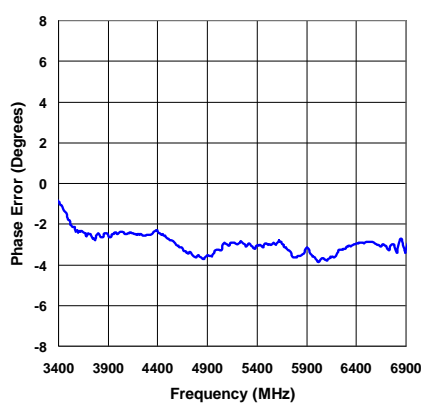

**Sideband Suppression**

